

Rocketail Installation Manual - Version 3.1

THIS DOCUMENT OUTLINES THE INSTALLATION PROCEDURE FOR THE ROCKETAIL AERODYNAMIC SYSTEM.



Rocketail install will take two people with experience about 35 minutes for a dry van and 1 hour and 15 minutes for a reefer. All installations should be performed by an experienced mechanic.

Revision History

Revision Date	Version	Description
1/1/2020	3	Added Automatic Collision Resonse hinges and AntiFriction rollers to wing.
9/8/2020	3.1	Added 3M VHB tape to leading edge of Top Element.

EMISSION-RELATED INSTALLATION INSTRUCTION
FAILING TO FOLLOW THESE INSTUCTIONS WHEN COMPLETING ASSEMBLY OF A HEAVY-DUTY MOTOR VEHICLE VIOLATES FEDERAL LAW, SUBJECTS TO FINES OR OTHER PENALTIES AS DECRIBED BY THE CLEAN AIR ACT.



WARNING
LOOSE OR DAMAGED PARTS CAN CAUSE SERIOUS INJURY OR DEATH.
PRIOR TO EVERY TRIP INSPECT THE SYSTEM AND ENSURE IT IS SECURLY MOUNTED TO THE TRAILER.

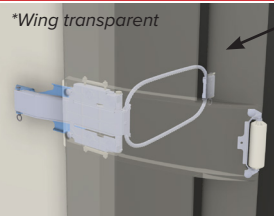

Check hinge connections and look for hinge damage.

Check Top Element and ensure leading edge is tight against trailer.

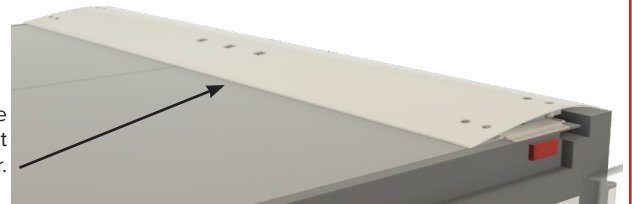

Required Tools

Tape Measure - Speed Square - Sharpie - Drill - 1/4" Rivet Tool - Ladder - Acetone
Wrenches: 3/8", 7/16" & 1/2" - Drill Bits: F & 3/8" - [Silicone for Reefer]

Note: Due to the nature of the product, all hardware is stainless steel. Therefore, hardware galling is possible and we recommend tightening hardware by hand and use an anti-seize to reduce the likelihood.

1 Mark trailer frame for Base Plate install

Trailer doors closed

- Measure from rear header and mark rear trailer post at 23" and 72". Repeat on both sides of trailer.
- Use speed square to mark the width of the trailer frame post with a straight line.



Note: Measure from rear header.

Tools & Materials: tape measure, speed square, sharpie

2 Attach Base Plates

Trailer doors opened to 90°

- Center Base Plate on mark from step one and align back of Base Plate with back of trailer frame.
- Use Base Plate as guide to mark holes.
- Only mark top hole and center hole for now.
- Using F drill bit, drill top and center holes.
- Insert and pop the 1/4" stainless steel structural rivet in top and center holes.

X4

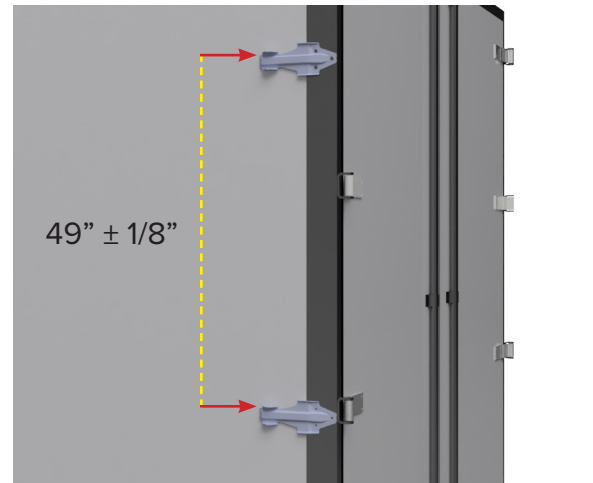
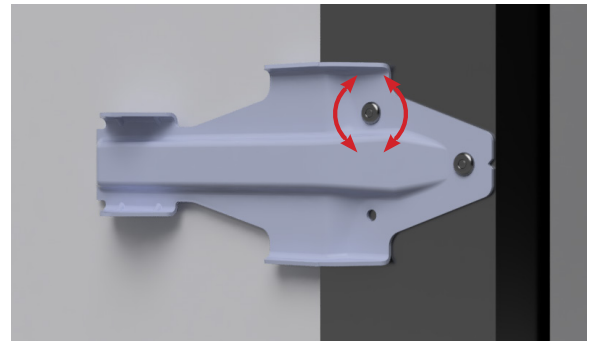

Note: center hole has additional tolerance to allow micro adjustments prior to fixing position with final rivet.

- Ensure Base Plate is square using speed square.
- Measurement from top of Base Plate to the top of the second Base Plate should be **49" ± 1/8"**.
- Once the position is correct, drill the bottom holes and pop the remainder of the rivets.



Only use the provided 1/4" stainless steel structural rivets. Watch for wires in the post.

Tools & Materials: (4) Base Plates, drill, F drill bit, sharpie, (12) 1/4" stainless steel structural rivets, 1/4" rivet tool

3 Attach Door Bracket

Trailer doors closed

- Measure and mark trailer door at 16" from side of trailer.
- Ensure mark is level with center of Base Plate.
- Drill hole using a 3/8" drill bit.

X4

Note: Park trailer on level surface.

Tools & Materials: tape measure, sharpie, drill, 3/8" drill bit

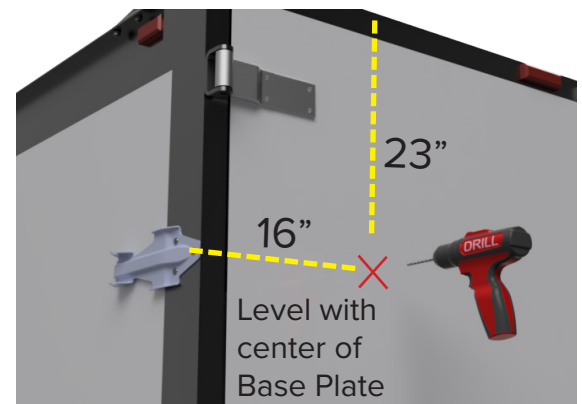

Trailer doors opened to 90°

X4

- Dry Van - attach Door Bracket using provided 1.5" carriage bolts, oversized washer and 5/16" - 18 lock nut.
- Reefer - attach Door Bracket using provided 4.5" carriage bolts, oversized washer and 5/16" - 18 lock nut.
- Tighten lock nuts with 1/2" wrench to 11 ft-lbs torque.

Note: For reefers, inject silicone into drill hole before inserting carriage bot. Hardware is stainless steel, use an anti-seize lubricant to prevent galling.

Tools & Materials: (4) Door Brackets, (4) 1.5" carriage bolt [4.5" for reefers], (4) oversized washer, (4) 5/16"-18 lock nut, 1/2" wrench



4 Hang Wings on Base Plates and Door Brackets

X4

Trailer doors opened to 90°

- Hang the Rockettail Wing on the Base Plate using provided 5/16" clevis pin.
- Attach Cable Bracket to Door Bracket using provided (2) 1/4" clevis pin.
- Add provided circle cotter to each clevis pin to secure.

Tools & Materials: (2) Rockettail Wing, (4) 5/16" clevis pin, (4) 1/4" clevis pin, (8) circle cotter

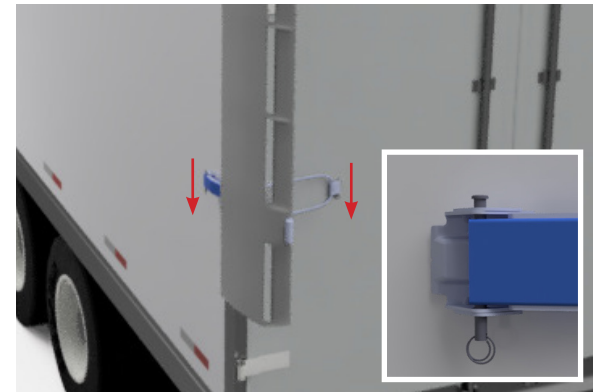

5 Mount Top Element *Note: Inspect roof for damage and repair if necessary. Leading edge of Top Element should sit flush against trailer roof.*

- Ensure Mounting Plate can slide with firm pressure. DO NOT tighten pre-assembled bolts on Mounting Plate.



⚠ Mounting Plates need to slide to allow for thermal expansion/contraction. DO NOT OVERTIGHTEN.



- Align Top Element with back of trailer frame and center on trailer - DO NOT extend over the back of the trailer frame.
- Slide Mounting Plates so that they are aligned with edge of trailer flange.
- Use Mounting Plates as guide to drill holes through flange using an F drill bit.
- Loosly attach Mounting Plates to trailer flange using provided hardware - 3 bolts per side, evenly distributed.
- Once the Top Element is positioned correctly, clean just below the leading edge of the Top Element with acetone or similar.
- Once acetone is dry, remove backing of VHB tape on leading edge and press to trailer with 15lbs force for proper adhesion.
- Fully tighten bolts to trailer with 6 ft-lbs torque.

⚠ Ensure trailer ride height does not exceed 13'6" with Top Element.

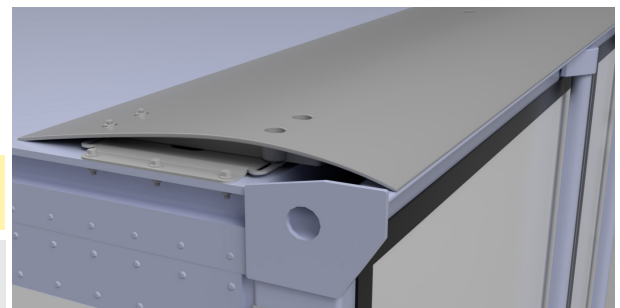





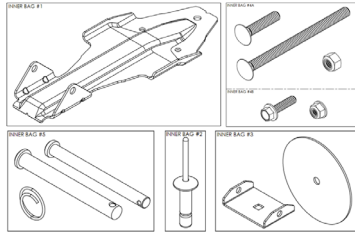

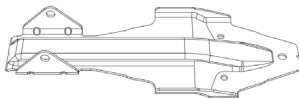

Tools & Materials: 7/16 and 3/8 wrench, (6) 1" 1/4-20 flanged hex screw, (6) 1/4-20 flanged lock nut, acetone

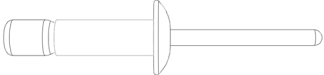

Rocketail Parts List

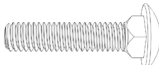
QUANTITY	PART NAME	PART NUMBER	DESCRIPTION	IMAGE
2	Wing	601100	Wing Assembly	
1	Top Element	601200	Top Element Assembly	
1	Hardware Bag	601112	Brackets and hardware for installation	

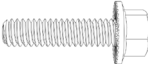
Hardware Bag - 601112

ITEM #	PART NO.	DESCRIPTION	QTY	IMAGE
1	601102	Base Plate	4	
2	601103	Door Bracket	4	
3	601104	Oversized Washer	4	
4	601111	1/4" stainless steel structural rivet	13*	
5		2.75" 5/16 clevis pin, SS	4	
6		2.75" 1/4 clevis pin, SS	4	
7		circle cotter, SS	10*	
8		1.5" 5/16-18 carriage bolt [Dry Van]	4	
9		4.5" 5/16-18 carriage bolt [Reefer]	4	
10		5/16-18 hex nut, nylon lock	5*	
11		1" 1/4-20 flanged serrated hex screw	7*	
12		1/4-20 hex nylon lock, nonmarring flanged	7*	

* INDICATES EXTRA PART